

GRX-DACPI Front Panel (cover open)

Description

The GRX-DACPI Control Unit permits *GRAFIK Eye* 3000 and 4000 Series systems to automatically select preset lighting scenes in response to available daylight for optimum light levels and energy savings.

The GRX-DACPI allows you to define four ranges of ambient light. These ranges are defined as a percentage of maximum available sunlight. For example:

- Range 1 can be defined as 0-25%.
- Range 2 can be defined as 26-50%.
- Range 3 can be defined as 51-75%.
- Range 4 can be defined as 76-100%.

The GRX-DACPI will compare the amount of sunlight currently available with the user-defined ranges and, based on this comparison, select an appropriate lighting scene. This means the *GRAFIK Eye* system can, for example, decrease the amount of light on sunny days or increase the amount of light on overcast days.

To determine the amount of available sunlight, the GRX-DACPI is used in conjunction with a Lutron MW-PS PhotoCell located within the lighting space. **The PhotoCell should be located so it measures available sunlight (along or near external walls with windows) without being affected by artificial light sources.** Alternately, a 0-10V signal from photo measurement equipment (by others) may be used in place of the Lutron PhotoCell.

Threshold Table

The diagram shows four ranges of ambient light defined by thresholds. Threshold 1 is at 25%, Threshold 2 at 50%, and Threshold 3 at 75%. RANGE 1 is 0-25%, RANGE 2 is 26-50%, RANGE 3 is 51-75%, and RANGE 4 is 76-100%.

Scenes	1	2	3	4	Comprise Scene Bank* 1
Scenes	5	6	7	8	Comprise Scene Bank* 2
Scenes	9	10	11	12	Comprise Scene Bank* 3
Scenes	13	14	15	16	Comprise Scene Bank* 4

*See Step 5 on page 3.

Important Notes

1. READ ALL INSTRUCTIONS CAREFULLY BEFORE STARTING INSTALLATION.
2. This control must be installed by a qualified electrician.
3. Install in accordance with the National Electric Code® and all applicable local regulations.
4. Turn power OFF at the control panel before installing controls. Do not connect high-voltage power to low-voltage terminals. Improper wiring can result in personal injury and damage to the control or other equipment.
5. Use only a cloth with warm water and mild soap to clean faceplates (no chemical cleaners).

Installation

1. **Mount wallbox.** The GRX-DACPI requires a 4-gang wallbox, with a minimum depth of 3.5" (84mm).

To prevent damage to faceplate when wiring control, snap off the faceplate by pulling outward at each corner.

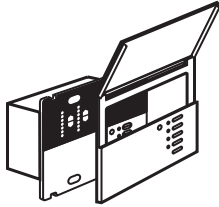

2. **Wire control.** Strip 1/2" (12mm) insulation from all wires prior to inserting them into the terminals on the back of the GRX-DACPI control.

- Power connections (Class 2/PELV). The GRX-DACPI is wired using (2) #18 AWG wires as the power cable.
- Data connections. Use (1) pair shielded, twisted #18 AWG for the data cable. (See diagram below.)

GRX-DACPI Wiring

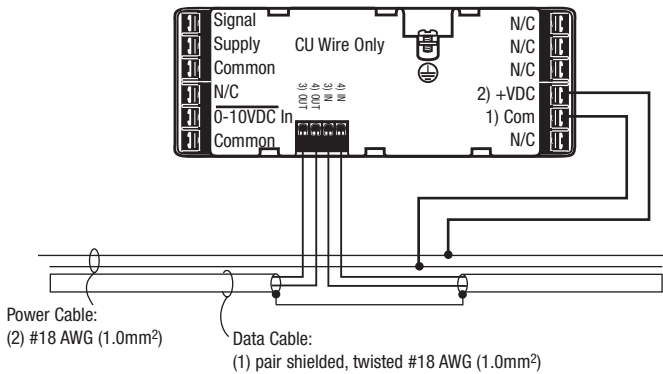

3. **Wire MW-PS PhotoCell or 0-10V signal.** Use only one MW-PS per GRX-DACPI.

MW-PS PhotoCell Wiring

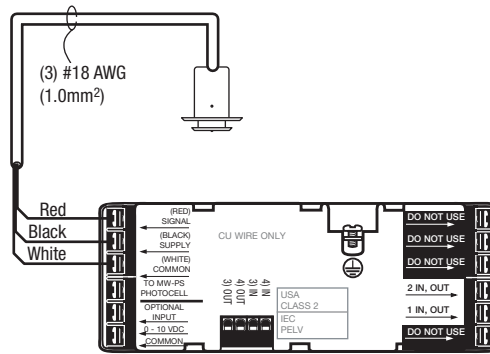

0-10VDC Signal Wiring

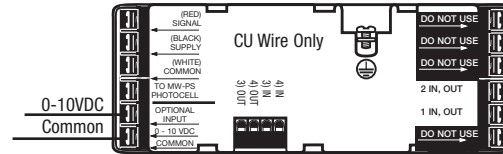

4. **Mount the GRX-DACPI.** Push all wires in the wallbox and mount as shown. Snap faceplate back on by pushing inward at each corner.

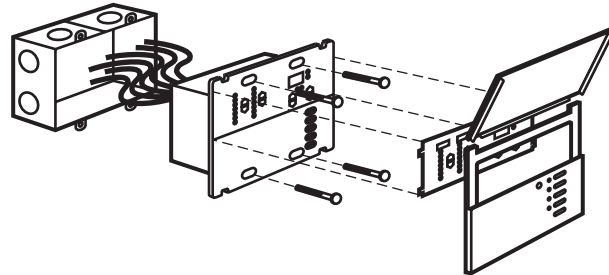

Programming

1. **Enter Programming Mode.** Simultaneously press and hold Scene Select buttons 1 and 5 for 5 seconds until the control indicates Programming Mode by showing its address in the two-digit display window and by cycling through the four Scene Select LEDs.

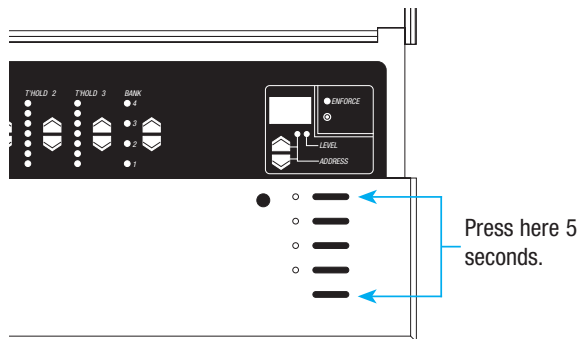

2. **Calibrate PhotoCell input.** With the GRX-DACPI in Programming Mode and the PhotoCell receiving maximum ambient light (or the 0-10V input set to 10V), press the ON button. The PhotoCell LED bargraph will begin to blink, and the PhotoCell level will be displayed in the two-digit display. Press the ON button a second time. During calibration, the PhotoCell LED bargraph will go blank, and the two-digit display will show "00". When the GRX-DACPI has completed calibration, the PhotoCell LED bargraph will be fully lit, and the two-digit display will show "99".

3. **Define four ranges of ambient light.** The four (4) ranges of ambient light are separated by three (3) ascending Thresholds. To accomplish the four ranges in the description example on page 1, set the Thresholds as follows:

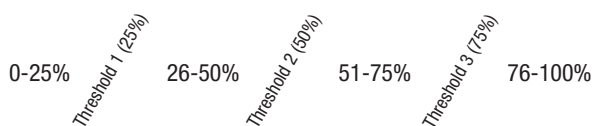

To program these Thresholds with the GRX-DACPI in Programming Mode, select a Threshold by pressing its Raise or Lower button. The two-digit display will show the Threshold's currently programmed level, and the LED bargraph will blink. Once the Threshold is selected, use its Raise or Lower button to adjust the programmed Threshold level up or down. Remember, Threshold 1 must be less than Threshold 2, which must be less than Threshold 3.

4. **Set GRX-DACPI Addresses.** The GRX-DACPI Address (1-16) may be changed while the control is in Programming Mode. The Address Raise and Lower buttons are located immediately below the two-digit display (see the diagram on page 1). During address adjustments, the address will be displayed in the two-digit display and the "ADDRESS" LED immediately below the display will be lit.

5. **Exit Programming Mode (Return to Operating Mode).** To exit Programming Mode, press and hold Scene Select buttons 1 and 5 for 5 seconds.

Note: If unit is left unattended for more than 10 minutes, it will automatically exit Programming Mode.

Additional GRX-DACPI Features

1. Manual Scene Selection

The four Scene Select buttons on the GRX-DACPI allow manual Scene selection within the currently selected Bank (see 2, 3, and 5 below for more information). The fifth button is used as an "Off" button, and to enter and exit Programming Mode.

Note: If the GRX-DACPI unit is in the OFF state, preset lighting scenes will not be selected on GRAFIK Eye units on the link even if the daylight level changes. Also, if a *GRAFIK Eye* 3000 or 4000 Series main unit on the link is in the OFF state, the GRX-DACPI unit will not override that main unit's setting and select a preset lighting scene if the daylight level changes.

2. Range Qualification

When the PhotoCell level moves from one range to the next, it starts (or resets) a 2-minute timer. For the GRX-DACPI to select a new Scene, the PhotoCell must stay within a given range for at least 2 minutes. This prevents the "passing cloud" effect, during which lights could constantly change in response to short, transient PhotoCell conditions. Also, the GRX-DACPI scenes in the *GRAFIK Eye* system should have relatively long fade times. If Scene Select buttons on the GRX-DACPI are used, these Scenes are selected immediately and remain selected until a new range is detected by the PhotoCell, the Enforce option re-selects a scene, or the Bank is changed, any of which cause an immediate Scene selection (see 3 below).

3. Enforce Lighting Option

The Enforce button will alternately enable/disable this option. Enforce is enabled when its LED is lit. When Enforce is enabled, the GRX-DACPI will select a Scene every 5 minutes, even if the PhotoCell level remains steady. This option addresses a user in the space who, for example, manually sets the lights on at full and then goes home. Any new Scene selections made locally from the GRX-DACPI or remotely will reset this 5-minute timer. When Enforce is disabled, the GRX-DACPI selects Scenes only when the PhotoCell level moves from one range to another and stays in the new range for at least 2 minutes. Without the Enforce option, given the scenario above and a steady-state PhotoCell level, lights would stay ON at full indefinitely, even though the GRX-DACPI may be indicating a much lower level.

4. Temporary GRX-DACPI Adjustments

The GRX-DACPI Threshold levels may be temporarily adjusted up or down while in Operating Mode. Pressing either the Threshold Raise or Lower button causes that Threshold's LED bar-graph to blink and its current level to be displayed in the two-digit display. The Enforce option may also be temporarily enabled or disabled while in Operating Mode.

Note: All adjustments made while in Operating Mode are temporary and will stay in effect only until the next Bank is selected.

5. Multiple Banks of Preset Scenes

Each time the PhotoCell value changes from one range to another and meets the 2-minute requirement, the GRX-DACPI selects one of the four preset scenes in the GRAFIK Eye System. These four scenes constitute a "Bank" of scenes. The GRX-DACPI can change the group of four preset scenes from which it selects by changing its Bank. The Bank setting may be changed locally by pressing The Bank Select buttons on the GRX-DACPI faceplate.

- Bank 1 selects Scenes 1-4.
- Bank 2 selects Scenes 5-8.
- Bank 3 selects Scenes 9-12.
- Bank 4 selects Scenes 13-16.

Note: Each Bank may be programmed with its own set of Threshold levels and with regard to the Enforce option.

Whenever a Bank changes, the GRX-DACPI immediately selects a scene based on the new Bank and current PhotoCell level, bypassing the 2-minute requirement. (This ensures the lighting space is in a Scene appropriate to the current Bank, even if the PhotoCell level does not change.) Also, when the Bank changes, the new Bank's Threshold values and Enforce option are installed.

Notes

1. Connections to link are made inside the Wallstation backbox or in a junction box (provided by others) located no more than 8' (2.4m) from the Wallstation.
2. Connections to numbered terminals on the GRX-DACPI Wallstations are wired 1:1 with numbered terminals.
3. Link wiring **MUST NOT** be run in the same raceway as the Line Voltage or Mains wiring.
4. Data cable shield continuity must be maintained throughout the link. **DO NOT** connect the shield to earth/ground.

Internet: www.lutron.com
E-mail: product@lutron.com

WORLD HEADQUARTERS

Lutron Electronics Co., Inc.
7200 Suter Road, Coopersburg, PA 18036
TEL +1-610-282-3800
FAX +1-610-282-1243

EUROPEAN HEADQUARTERS

Lutron EA Ltd.
6 Sovereign Close, Wapping London, E1W 3JF
United Kingdom
TEL +44-207-702-0657
FAX +44-207-480-6899
FREEPHONE (UK) 0800-282-107

WORLDWIDE OFFICES

Germany

Lutron Electronics GmbH, Landsberger Allee 201,
13055 Berlin, Germany
TEL +49-30-9710-4590
FAX +49-30-9710-4591
FREEPHONE 00800-5887 6635

France

Lutron LTC, S.A.R.L.
90 rue de Villiers, 92300 Levallois-Perret France
TEL +33-(0)1-41-05-42-80
FAX +33-(0)1-41-05-01-80
FREEPHONE 0800-90-12-18

Italy

Lutron LDV, S.r.l.
FREEPHONE 800-979-208

Spain, Madrid

Lutron CC, S.R.L.
Calle Orense, 85, 28020 Madrid, Spain
TEL +34-91-567-8479
FAX +34-91-567-8478
FREEPHONE 0900-948-944

Spain, Barcelona

Lutron CC, S.R.L.
Gran Via Carlos III, 84, planta 3a, 08028,
Barcelona, Spain
TEL +34-93-496-5742
FAX +34-93-496-5701
FREEPHONE 0900-948-944

Hong Kong

Lutron GL Ltd.
Room 2808, 28/F, MLC Tower,
248 Queen's Road East, Wanchai, Hong Kong
TEL +852-2104-7733
FAX +852-2104-7633

Singapore

Lutron GL Ltd.
6A Upper Cross Street, Singapore 058326
TEL +65-6220-4666
FAX +65-6220-4333

Japan

Lutron Asuka Co. Ltd.
No. 16 Kowa Building, 4F, 1-9-20, Akasaka,
Minato-ku, Tokyo 107-0052 Japan
TEL +81-3-5575-8411
FAX +81-3-5575-8420

China, Beijing

Lutron GL Ltd.
5th. Floor, China Life Tower, No. 16, Chaowai Street,
Chaoyang District, Beijing 100020 China
TEL +86-10-5877-1817
FAX +86-10-5877-1816

China, Shanghai

Lutron GL Ltd.
Suite 07, 39th. Floor, Plaza 66,
1266 Nan Jing West Road, Shanghai, 200040 China
TEL +86-21-62881473
FAX +86-21-62881751

LIMITED WARRANTY

Lutron will, at its option, repair or replace any unit that is defective in materials or manufacture within one year after purchase. For warranty service, return unit to place of purchase or mail to Lutron at 7200 Suter Rd., Coopersburg, PA 18036-1299, postage pre-paid.

This warranty is in lieu of all other express warranties, and the implied warranty of merchantability is limited to one year from purchase. This warranty does not cover the cost of installation, removal or reinstallation, or damage resulting from misuse, abuse, or improper or incorrect repair, or damage from improper wiring or installation. This warranty does not cover incidental or consequential damages. Lutron's liability on any claim for damages arising out of or in connection with the manufacture, sale, installation, delivery, or use of the unit shall never exceed the purchase price of the unit.

This warranty gives you specific legal rights, and you may also have other rights which vary from state to state. Some states do not allow limitations on how long an implied warranty lasts, so the above limitation may not apply to you. Some states do not allow the exclusion or limitation of incidental or consequential damages, so the above limitation or exclusion may not apply to you.

Lutron, the sunburst logo, and GRAFIK Eye are registered trademarks of Lutron Electronics Co., Inc.

National Electric Code is a registered trademark of the National Fire Protection Association, Inc., Quincy, Massachusetts.

© 2005 Lutron Electronics Co., Inc.



Lutron Electronics Co., Inc.
Made and printed in U.S.A.
P/N 040-179 Rev. B 6/05