

COLOR AND FINISH CODES

# SO-7BN-\_\_\_\_-\_\_\_\_ 7 Button Wallstation

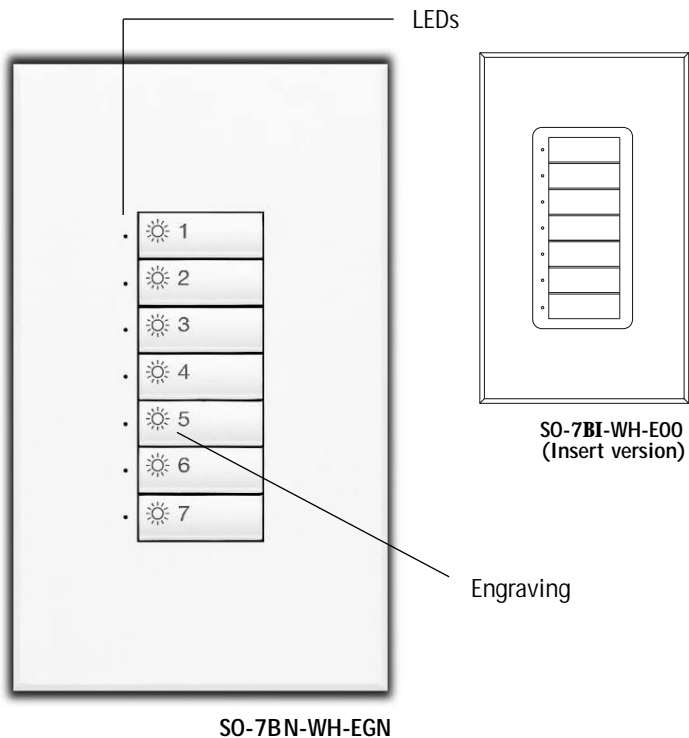

## DESCRIPTION

Used to select scenes.

- Large, rounded buttons are easy to touch.
- Backlit buttons with optional on-button engraving make it easy to find and operate the control in low light conditions.
- Optional on-button engraving is angled up to the eye for easy reading.
- Recalls preset light levels for scenes
- Reflects door status of partitions
- Select OMX-DACPI Daylight Control bank of scenes
- Can be ganged with *seeTouch* Wallstations
- Can be custom-configured for other functions
- Works with Grafik 5000/6000 Systems.

## SPECIAL FINISH AND ENGRAVING

- On-button engraving is available for improved clarity of control functions in low light conditions.
- Three engraving options are available: General Engraving, Standard Engraving, & Non-Standard Text Engraving. For more details, please refer to the *seeTouch* Ordering Guide (P/N 367-274) or visit the website at [www.lutron.com/seeTouch](http://www.lutron.com/seeTouch).

JOB NAME:	MODEL NUMBERS:
JOB NUMBER:	

**SPECIFICATIONS**

**Power**

Operating voltage: Low-voltage Class 2 (PELV), 32VDC.

**Key Design Features**

- Field-changeable button and faceplate assemblies make for easy customization.
- Front-located DIP switches allow change of function without removing the unit from the wall.
- Meets IEC 801-2. Tested to withstand 15kV electro-static discharge without damage or memory loss.
- Has faceplate that snaps on with no visible means of attachment.
- Available as an "insert" style control for multi-gangging.
- Can be ganged to share a common faceplate with NovaT☆ and Vareo Dimmers. To order new Wallplates for multi-gangging, specify "R3" openings in a Lutron NovaT multi-gang FB (fins broken) Series model number.
- Use Button Replacement Kits to change color, button configuration, engraving, or between insert and non-insert versions.
- Button Replacement Kits may also be used to convert between non-insert and insert configurations.

**System Communications and Capacity**

- Low-voltage Class 2 (PELV) wiring connects Wallstations to Processor Panel.
- You can link up to 32 Wallstations, Control Units, and/or Control Interfaces per Class 2 (PELV) wiring link.

**Terminals**

Capacity: Accept up to two #18 AWG (1.0mm<sup>2</sup>) typical.

**Environment**

32-104°F (0-40°C). Relative humidity less than 90% non-condensing.

**DIMENSIONS**

**Front View**

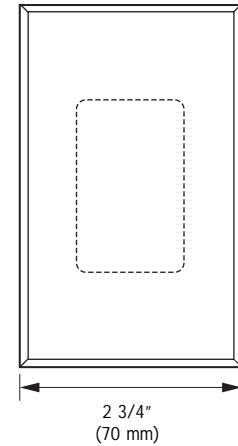

**Side View**

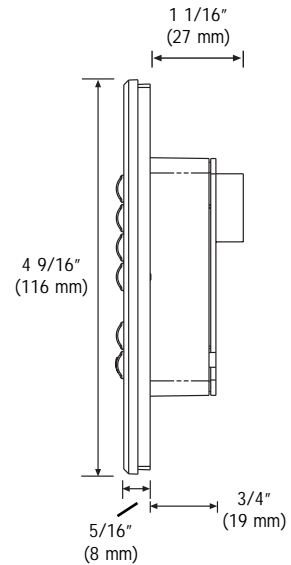

**MOUNTING-** Typical backbox dimensions: 95mm (3.74") high, 55mm (2.17") wide, 70mm (2.75") deep.

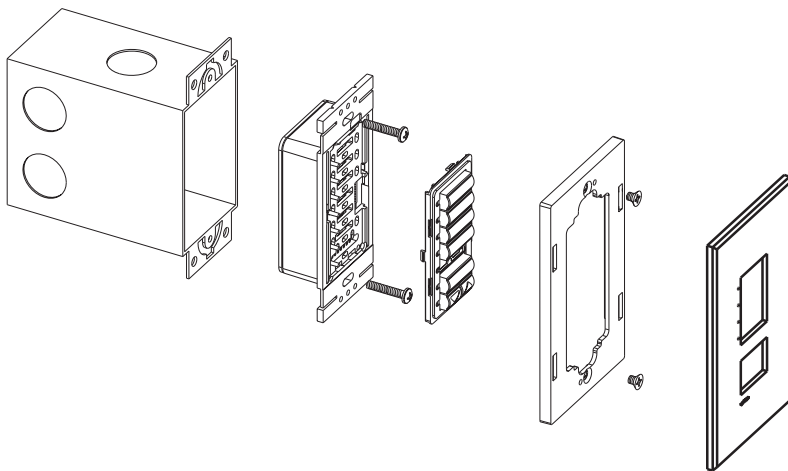

**Back View**

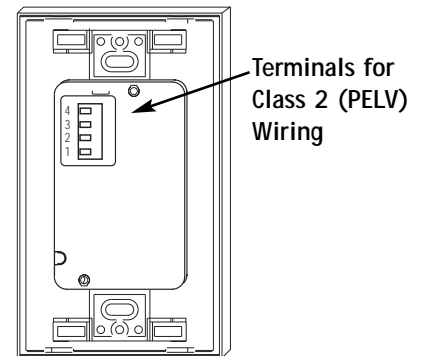

JOB NAME:	MODEL NUMBERS:
JOB NUMBER:	

# Color/Finish and Customizing Information

## COLORS/FINISH

### Matte Finishes

White	WH
Ivory	IV*
Beige	BE
Gray	GR*
Brown	BR
Black	BL

\* GR, IV not currently backlighted

### Metal Finishes

(Standard with Black Plastic Buttons)

Bright Brass	BB
Bright Chrome	BC
Bright Nickel	BN
Satin Brass	SB
Satin Chrome	SC
Satin Nickel	SN
Antique Brass	QB
Antique Bronze	QZ

### Gloss Finishes

(Available with Insert (I) style controls only; ship with Claro® style faceplates)

White	GWH
Light Almond	GLA

### Anodized Aluminum

Clear	CLA
Black	BLA
Brass	BRA

### Backlighting Notes:

Illuminated text (translucent text on buttons) is available for these colors: BL and BR (also applies to all metal finishes).

Illuminated buttons (with black text on buttons) are available for these colors/finishes: WH, BE, GR, GWH\*, GLA\*.

\* Insert (I) style controls only

## MULTI-GANGING

1. Order Insert (I) style controls.
2. To order new Wallplates for multi-ganging, specify "R3" openings in a Lutron NovaT multi-gang FB (fins broken) Series model number.

### Examples:

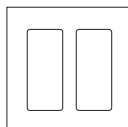

Wallplate for 2 Seetouch Wallstations, Model # **NT-R3-R3-FB**-(color)

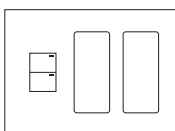

Wallplate for other Lutron controls and 2 Seetouch Wallstations, Model # **NT-T8-R3-R3-FB**-(color)

**Note:** New button inserts are **not** included with multi-ganging Wallplates.

## BUTTON REPLACEMENT KITS

Use Button Replacement Kits to change: colors, button configuration, engraving, between insert and non-insert versions.

### Non-Insert Kit

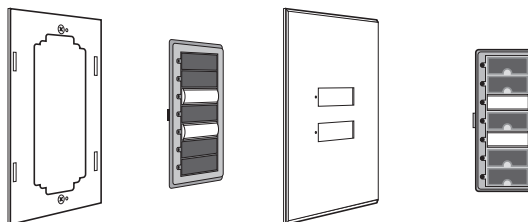

Each Kit includes an adapter, button assembly, and wallplate

### Insert Kit

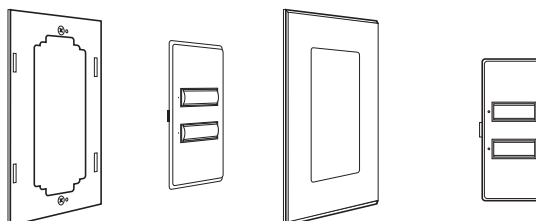

JOB NAME:	MODEL NUMBERS:
JOB NUMBER:	

**LOW-VOLTAGE CLASS 2 (PELV) WIRING**

Use low-voltage Class 2 (PELV) wiring to daisy-chain Wallstations to the Processor Panel.

- Two #12 AWG (2.5mm<sup>2</sup>) conductors for common (terminal 1) and 24VFW (terminal 2). These won't fit in terminals. Connect as shown.
- One shielded, twisted pair #18 AWG (1.0mm<sup>2</sup>) for data link (terminals 3 and 4).
- Connect Drain/Shield as shown.
  - Do not connect to Ground (Earth) or Wallstation.
  - Connect the bare drain wires and cut off the outside shield.

Note: Some Wallstations have a D terminal for Drain. You can connect the Drain/Shield at this terminal.

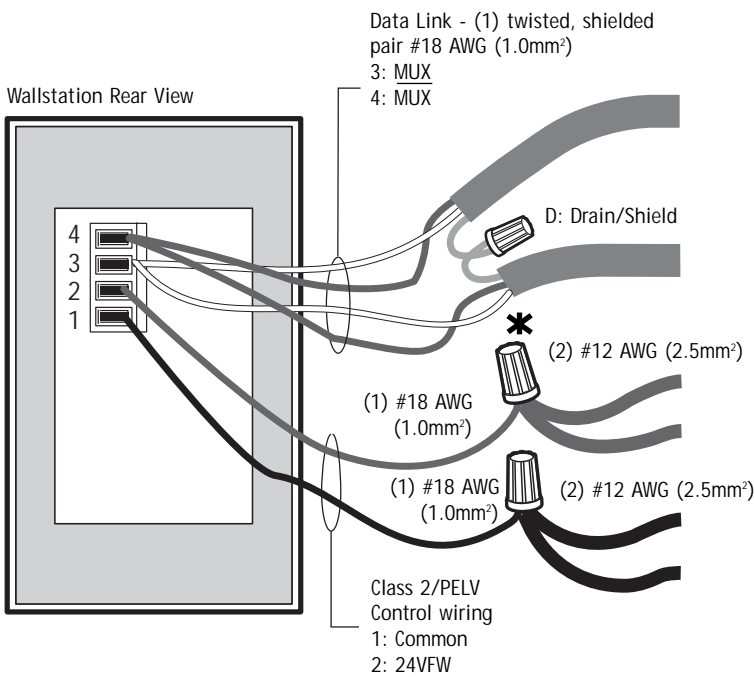

Make connections inside the wallbox. Or in a switchbox or junction box with a maximum wire length of 8 feet (2.5m) from the link to the Wallstation.

\* Use appropriate wire connecting devices as specified by local codes.

JOB NAME:	MODEL NUMBERS:
JOB NUMBER:	